

# THRED TAPER



THE WORLD'S ONLY AUTOMATIC TAPE WRAPPER

Model M7000

Teflon Tape Application Machine



---

OPERATING MANUAL

# INTRODUCTION

The Thred Taper M7000 was developed to automate the application of PTFE tape to threaded parts. Designed to increase productivity and quality, the Thred Taper consistently wraps parts in as little as two seconds versus up to 30 seconds for hand wrapping. This machine also provides many other advantages which include:

- Accurate and precise tape application with no reverse wrapping
- Tape applied into the thread root for proper sealing
- Tape will not unwrap during storage or shipping
- Prevents tape contamination into critical systems by maintaining a consistent “set-back” from fitting end
- Can apply 1-4 wraps of tape
- Short setup and changeover time
- Accommodates virtually any part up through  $\frac{3}{4}$ -inch
- Can wrap American Tapered, British Straight, or Metric threads

Thred Tape cartridges are available in five widths for a variety of part lengths. Our high quality tape is 3.5-mils thick, which is twice as thick as conventional thread sealant tape and requires fewer wraps. The specially designed cartridges also keep the tape clean until application.

We hope that the Thred Taper will be a valued addition to your manufacturing process. It will save you time and money, and you will see an increase in the quality and reliability of your wrapped parts.

Please feel free to contact Federal Process Corporation and your Thred Taper representative with any questions at (216) 464-6440, toll free (800) 846-7325 or [info@federalprocess.com](mailto:info@federalprocess.com).



# TABLE OF CONTENTS

## **SECTION 1: FIGURES .....Page 2-9**

Figure 1 – Front View.....	Page 2
Figure 2 – Left View.....	Page 2
Figure 3 – Right View.....	Page 3
Figure 4 – Rear View.....	Page 3
Figure 5 – Air Pressure Regulator Assemblies.....	Page 4
Figure 6 – Face Plate Assembly - Front View.....	Page 5
Figure 7 – Large Clamping Arm Assembly - Front View.....	Page 5
Figure 8 – Face Plate Assembly - Rear View Right.....	Page 6
Figure 9 – Face Plate Assembly - Rear View Left.....	Page 7
Figure 10 – Trigger Rod Switch Mechanism.....	Page 8
Figure 11 – Motor Assembly.....	Page 8
Figure 12 – Roller Installation.....	Page 9

## **SECTION 2: THRED TAPER INSTALLATION .....Page 10-11**

Machine Position.....	Page 10
Air Connection.....	Page 10
Tape Cartridge Mounting & Adjustment.....	Page 10
Trigger Rod Selection & Installation.....	Page 10
Roller Selection and Installation.....	Page 11
Part Location.....	Page 11

## **SECTION 3: THRED TAPER OPERATION .....Page 11-12**

## **SECTION 4: GENERAL MAINTENANCE & ADJUSTMENTS .....Page 12-13**

General Maintenance.....	Page 12
Lubricator Maintenance and Setting.....	Page 12
Clamping Pressure Regulator.....	Page 12
Part Changeover.....	Page 13

## **SECTION 5: TROUBLESHOOTING PROCEDURES .....Page 13**

## **SECTION 6: PROBLEMS/SOLUTIONS .....Page 14-15**

## **SECTION 7: APPENDIX .....Page 16-18**



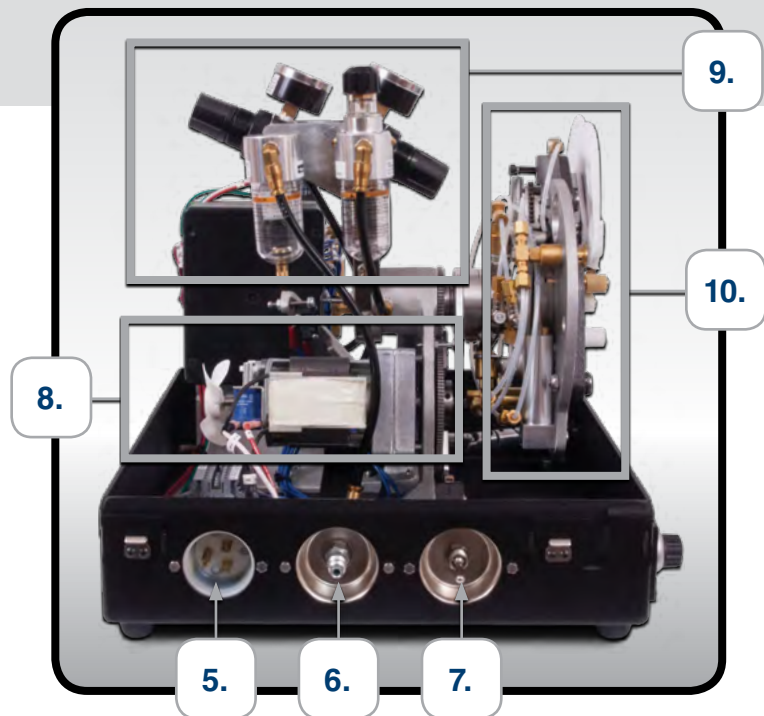
## FIGURE 1: FRONT VIEW

1. Wrap Number Selector Switch [66210]
2. Power On Light [61030]
3. Part Positioning Knob [67460]
4. Centering Disc [60051]



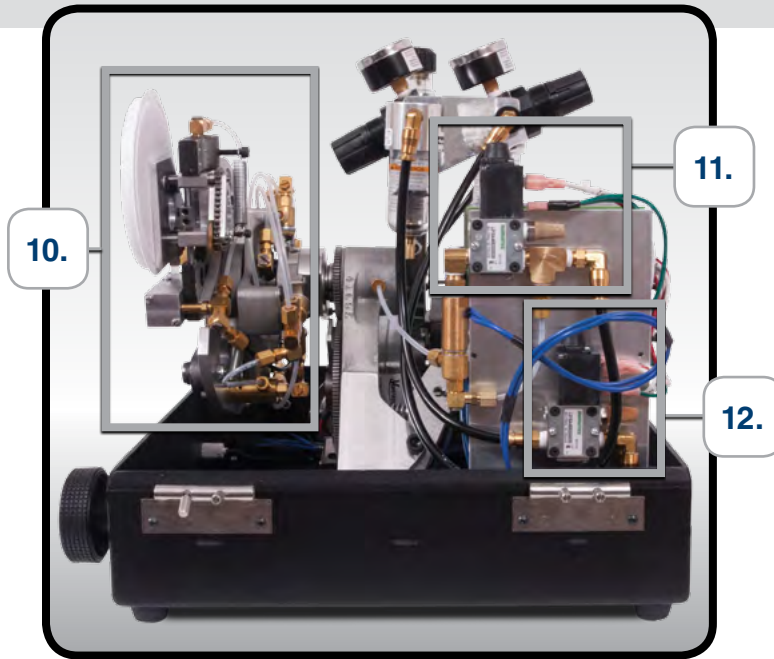
## FIGURE 2: LEFT VIEW

5. Electrical Receptacle [61020]
6. Air Intake Coupling [62650]
7. On/Off Switch [61040]
8. Motor Assembly [61081REV]  
(See Figure 11)
9. Air Pressure Regulator Assemblies [60772/67200]  
(See Figure 5)
10. Face Plate Assembly (See Figures 6 & 9)



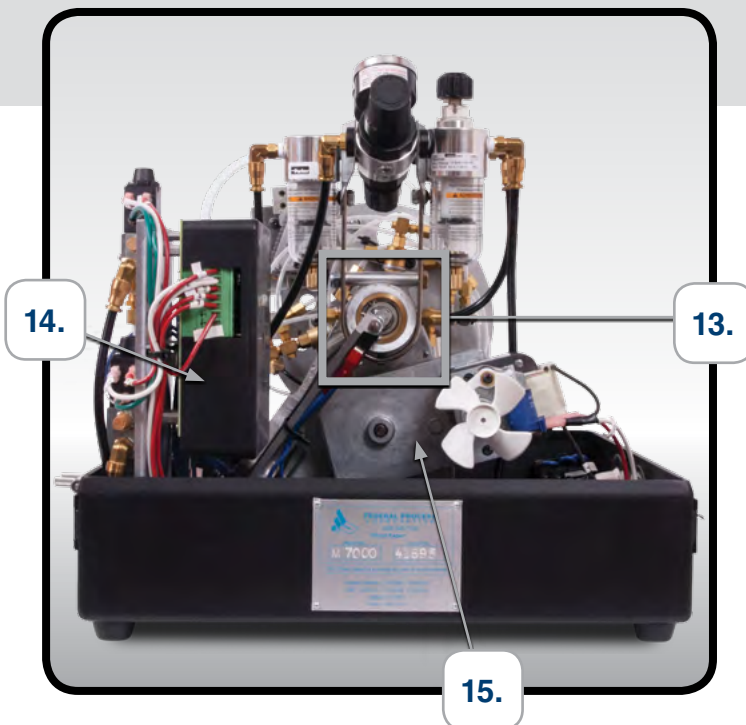


## FIGURE 3: RIGHT VIEW



- 10. Face Plate Assembly (See Figures 6 & 8)
- 11. Clamp Solenoid Assembly [67600]
- 12. FacePlate/Feed Solenoid Assembly [67650]

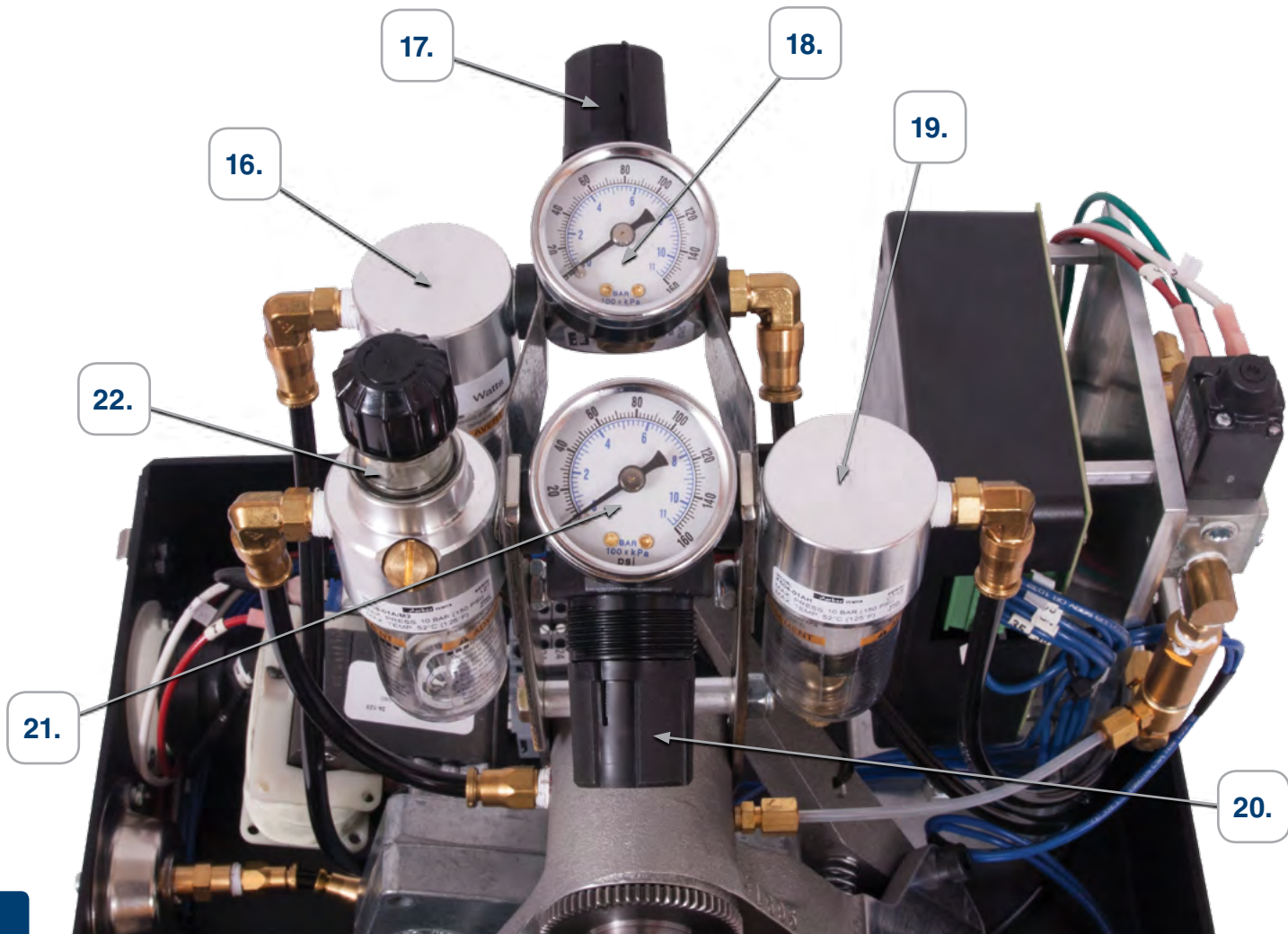
## FIGURE 4: REAR VIEW



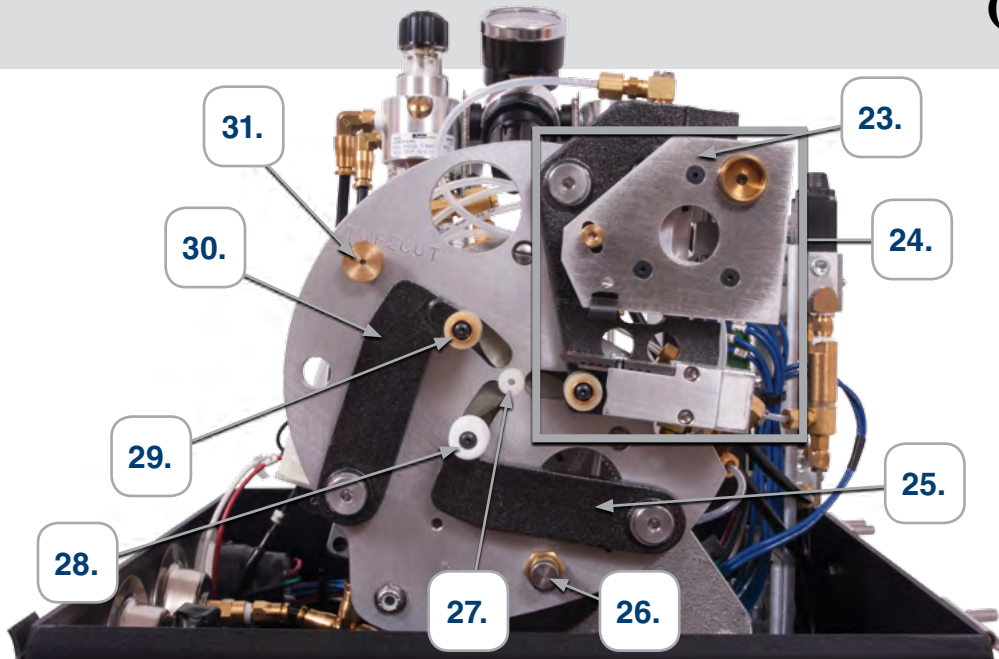
- 13. Trigger Rod Switch Mechanism (See Figure 10)
- 14. Controller [67315]
- 15. Motor Assembly [61081REV]

# FIGURE 5: AIR PRESSURE REGULATOR ASSEMBLIES (SEE FIGURE 2, ITEM 9)

- 16. Clamp Air Filter [62230]
- 17. Clamp Air Regulator [62240]
- 18. Clamp Air Regulator Gauge [62250]
- 19. Feed Air Filter [62230]
- 20. Feed Air Regulator [62240]
- 21. Feed Regulator Gauge [62250]
- 22. Feed Air Lubricator [62261]

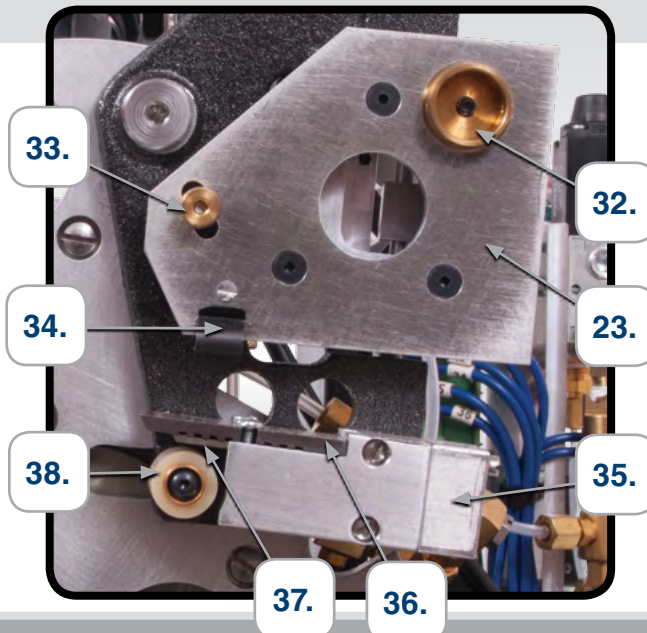


**FIGURE 6: FACE PLATE ASSEMBLY – FRONT VIEW**  
**(SEE FIGURES 2 & 3, ITEM 10)**



- 23. Tape Carrier Assembly [60424]
- 24. Large Clamping Arm Assembly [66500] (See Figure 7)
- 25. Small Clamping Arm [60252]
- 26. Clamping Pressure Regulator
- 27. Trigger Rod
- 28. Threaded Teflon Roller
- 29. Plain Rubber Roller [63250]
- 30. Small Clamping Arm [60252]
- 31. Tape Cut-Off Button

**FIGURE 7: LARGE CLAMPING ARM ASSEMBLY – FRONT VIEW**  
**(SEE FIGURE 6, ITEM 24)**

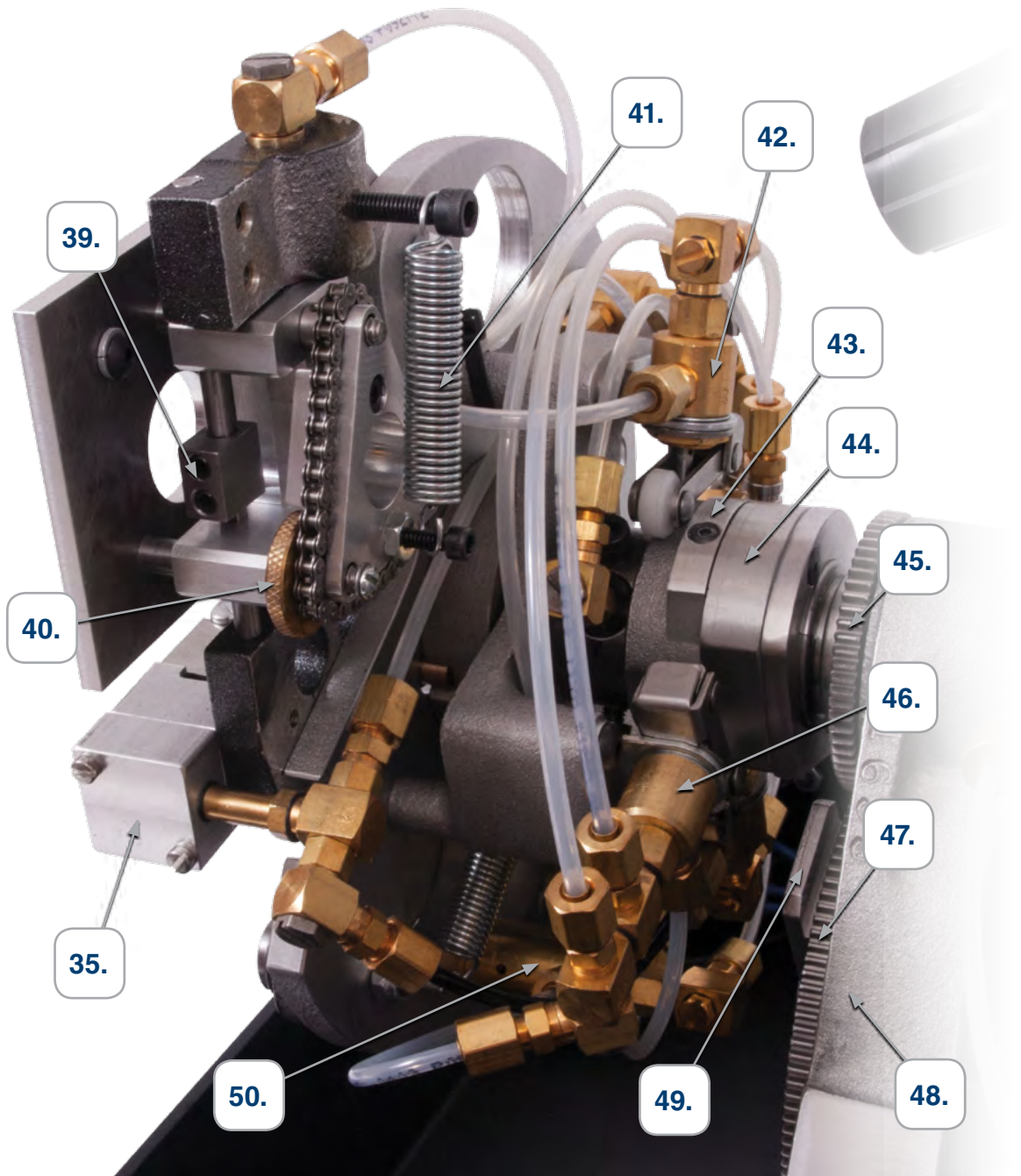


- 32. Large Stud [60790]
- 33. Small Stud [60781]
- 34. Tape Carrier Clip [60443]
- 35. Shear Assembly [66600]
- 36. Anvil [60365]
- 37. Blade [60134]
- 38. Sliced Rubber Roller [63350]



# FIGURE 8: FACE PLATE ASSEMBLY – REAR VIEW RIGHT (SEE FIGURE 3, ITEM 10)

- 39. Tape Carrier Stop Block [60960]
- 40. Knurled Tape Positioning Wheel [60101]
- 41. Tape Carrier Spring [60431]
- 42. Feed Valve Assembly [60860]
- 43. Cam Eclipse [60701]
- 44. Cam [60583]
- 45. Shaft Gear [60621]
- 46. Clamp Valve Assembly [67800]
- 47. Motor Gear [60643]
- 48. Stand
- 49. Breaker Switch Cam [60651]
- 50. Clamp Regulator Assembly [67850]



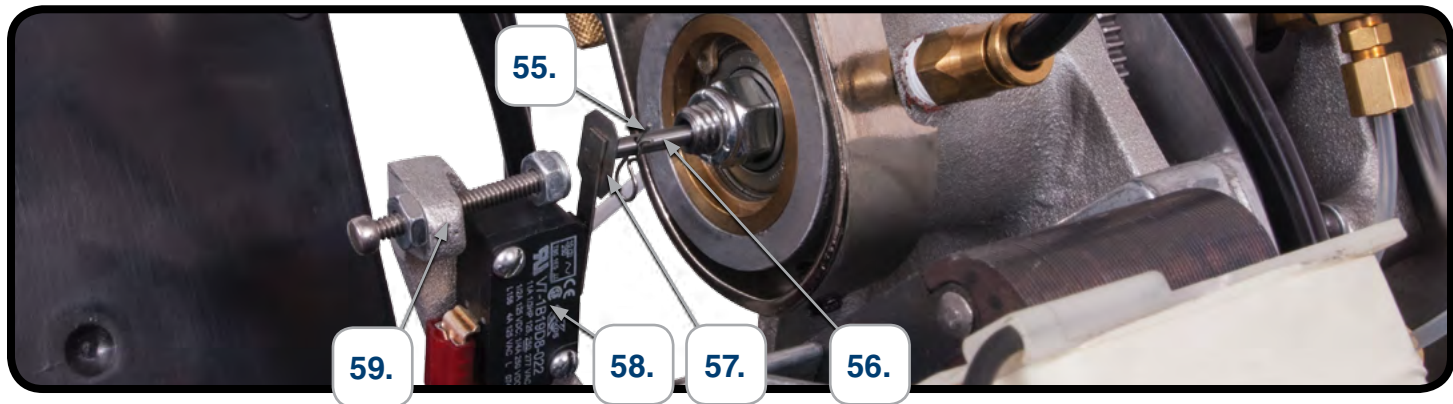


**FIGURE 9: FACE PLATE ASSEMBLY – REAR VIEW LEFT  
(SEE FIGURE 2, ITEM 10)**



- 51. Tape Cut-Off Valve [62580]
- 52. Clamping Cylinder Assembly [66400]
- 53. Shear Valve Assembly [60870]
- 54. Cam Microswitches [61090]

## FIGURE 10: TRIGGER ROD SWITCH MECHANISM (SEE FIGURE 4, ITEM 13)



55. Trigger Rod Retaining Clip [64090]

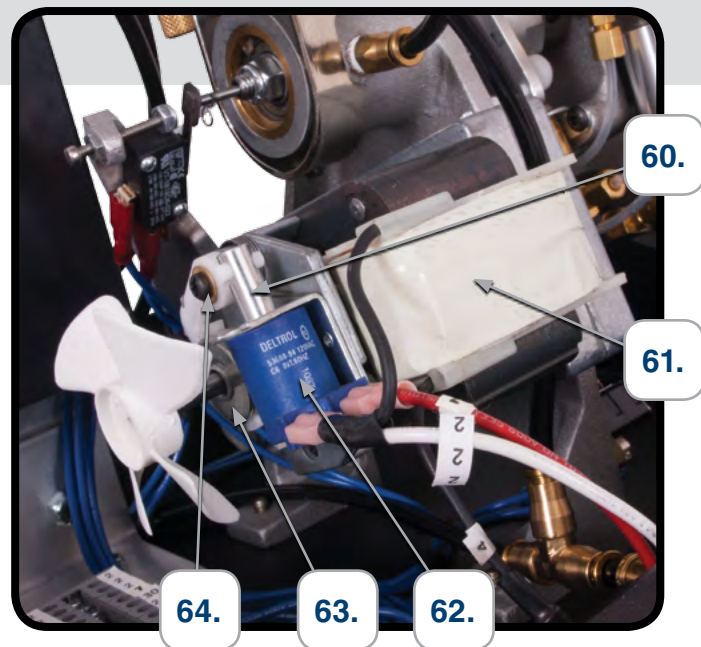
56. Trigger Rod

57. Trigger Switch Actuator

58. Trigger Switch [61071]

59. Part Positioning Lever [60520]

## FIGURE 11: MOTOR ASSEMBLY (SEE FIGURE 2, ITEM 8)



60. Motor Brake Release

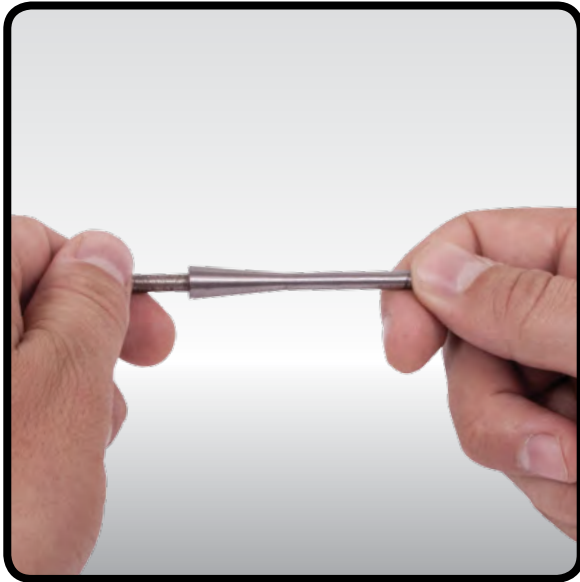
61. Motor Assembly [61091REV]

62. Brake Solenoid [61550]

63. Brake Hub Wheel [61510]

64. Brake Lever Arm [61500]

## FIGURE 12: ROLLER INSTALLATION



1. Moisten tool shaft with water



2. Place hub and sleeve on the tool



3. Force sleeve down onto tool shaft



4. Push down until sleeve covers hub



# SECTION 2: THRED TAPER INSTALLATION

## Machine Position

1. Set Thred Taper upright on a sturdy flat surface. Open hinged cover.  
**CAUTION: After set-up, the Thred Taper must be operated with the hinged cover in a closed position and the clear plastic Centering Disc (4) in place. (See Figure 1)**
2. Remove tool kit and packing material from inside the Thred Taper.
3. Make sure filter and lubricator bowls hang vertically on the Air Pressure Regulator Assemblies (9). (See Figure 2)
4. It is strongly recommended that all operators view the Thred Taper Training Video included with this machine before proceeding with installation.

## Air Connection

1. Set On/Off Switch (7) to off position (lever down). (See Figure 2)
2. Connect air supply to the Air Intake Coupling (6) on the side of the Thred Taper. A female quick connect couple is provided in the tool kit.  
**NOTE: The air supply should contain clean, dry air of at least 100 psi.**
3. Check air regulator gauges for proper pressure. Both should be factory preset. **The Feed Air Gauge (21) should read 90 psi while the Clamp Air Gauge (18) should read 60 psi.** If not, adjust these using the Clamp Air Regulator (17) and the Feed Air Regulator (20). (See Figure 5)
4. Attach a NEMA 5-15 power cord (not supplied with machine) to Electrical Receptacle (5) on machine and plug into electrical outlet. (See Figure 2)

## Tape Cartridge Mounting and Adjustment

**The Thred Taper should arrive with a tape cartridge already mounted. The following steps are to aid in replacing a depleted roll.**

1. Flex tape cartridge per the instructions on the label.
2. Snap off the protective plastic tip from the Thred Tape cartridge.  
**NOTE: Do not remove black O-ring on cartridge.**
3. Pull out 2- to 3-inches of tape from the cartridge.
4. Insert tape through slot in anvil (36). (See Figure 7)
5. Insert lower edge of tape cartridge (flange) into Tape Carrier Clip (34) on tape carrier assembly. (See Figure 7)  
**NOTE: Be careful not to bend clip when inserting cartridge.**
6. Line up and depress tape cartridge first on the Small Stud (33) and then on the Large Stud (32).
7. **Front to back adjustment:** Rotate Knurled Tape Positioning Wheel (40) to bring outer edge of metal guide on tape cartridge near the narrow front edge of the Anvil (36) slot. That is opposite the narrow, Face Plate edge. The Tape Carrier Assembly (23) may be pushed down to check this adjustment. (See Figures 7 and 8)  
**NOTE: This adjustment should be checked every time tape is changed.**
8. The O-ring on the tape cartridge should just touch the Anvil (36) when the Tape Carrier Assembly (23) is fully depressed. If not, make adjustments to the Tape Carrier Stop Block (39) on the rear of Tape Carrier Assembly. Loosen setscrews and reposition Stop Block. Retighten screws once adjusted.
9. Push the Tape Cut-Off button (31) on the front of the Face Plate

## Trigger Rod Selection and Installation

The Trigger Rod (27, 56) is an 1/8-in. diameter, 7 3/4-in. long rod that runs through the center of the Thred Taper with a plastic tip on one end and a Trigger Rod Retaining Clip (55) on the other. Five Trigger Rods

of varying tip diameter are included with the machine to allow for the wrapping of different size parts. (See Figures 6 and 10)

1. **Selection of Trigger Rod: The plastic tip MUST have a slightly smaller diameter than the outside thread diameter of the part to be wrapped.**
2. Insert rod through the front center of the Face Plate Assembly (10). Insert Retaining Clip (55) into Trigger Rod.

### **Roller Selection and Installation**

There are three roller assemblies on the Thred Taper:

- Threaded Teflon Roller (28) at the 7 o'clock position on the Face Plate. (See Figure 6)
  - Plain Rubber (29) sleeve on a brass hub at the 11 o'clock position on the Face Plate. (See Figure 6)
  - Sliced Rubber (38) sleeve on a brass hub below Shear Assembly (35) at the 3 o'clock position on the Face Plate. **This position must always have a sliced roller.** (See Figure 7)
1. Determine if the part to be wrapped is tapered or not.
  2. Select brass rollers for both the sliced and plain rubber sleeves that correspond to the taper (or lack thereof) on the part.

3. Using the roller installation tool, put the plain and sliced rubber sleeves on the brass hubs. (See Figure 12)
4. Match threads of part to Threaded Teflon Roller (28); both must have the same threads per inch.  
**NOTE: For some smooth plastic parts, a sliced rubber roller may need to be used in place of a Teflon roller.**
5. Grease axles lightly and install selected rollers making sure the springs are on the axles between the rollers and clamping arms.

### **Part Location**

1. If not already open, take off Thred Taper cover.
2. Make sure On/Off Switch (7) is in the "off" position (lever down).
3. Push the Trigger Rod (27) with the part to the mechanical stop and hold.
4. Turn the Part Positioning Knob (3) on the front of the Thred Taper to position the part in or out for proper tape application. Typically, the tape should be placed one thread back from the end of the part.
5. Close the Thred Taper cover and secure all latches.

## **SECTION 3: THRED TAPER OPERATION**

1. Make sure the Thred Taper cover is closed and all latches are secured.
2. Adjust Centering Disc (4) so that the appropriate hole for the part to be wrapped is positioned at the trigger rod. (See Figure 1)
3. Set the number of wraps using the Wrap Number

- Selector Switch (1).
4. Turn On/Off Switch (7) to the "On" position (lever up). (See Figure 2)
5. While holding the part securely, push it into the Trigger Rod (27) **making sure that the threaded section is perpendicular to the front of the**

**machine.** The Thred Taper will automatically wrap the part with the desired number of wraps set.

6. Repeat Step 5 for wrapping identical parts.

**NOTE: For best and most cost-effective results, parts of the same diameter, thread length and threads per inch should be done in**

**batches. Operating parameters may need to be changed before wrapping different parts. These parameters are listed in Section 4, Part Changeover.**

## 4: GENERAL MAINTENANCE AND ADJUSTMENTS

### General Maintenance

Regular maintenance on the Thred Taper should include:

- Clean machine of oil, dust, etc.
- Visual inspection for loose parts or screws, kinked air lines, air leaks and worn parts. Repair and replace as necessary.
- Oil level in lubricator should be checked and refilled (10ml or 2 tsp. max).
- Air filters should be cleaned every 6 months.
- Clean shear assembly of dust by carefully removing only the Blade (37) and Anvil (36). Once clean, apply a light coat of oil before reassembling.
- Replace worn rubber sleeves, rollers, and hubs as needed. Grease axles before reinstalling rollers.

**NOTE: When necessary, it is recommended that Blades and Anvils be sent back to the factory for resharpener. It may be advisable to have a second Blade and Anvil set on hand for operation during these times.**

A regular maintenance program should keep the Thred Taper in good working condition, drastically reducing downtime.

### Lubricator Maintenance and Setting

1. **To add oil to the Feed Air Lubricator (22), first disconnect air line from the Air Intake Coupling (6). (See Figures 2 and 5)**
2. Remove Brass fill plug at top of lubricator.
3. Fill Lubricator with 10ml or 2 tsp. pneumatic tool oil and replace fill plug.
4. Reconnect air line to Air Intake Coupling.

The lubricators are factory set at 1 drop per 50 revolutions and, in general, this setting should not need to be changed. Clockwise rotation of the regulator knob decreases the amount of lubrication. **Do not turn regulator knob more than a 1/2 turn counter-clockwise from the closed position or flooding of the machine will result.**

**NOTE: The Lubricator bowl should be cleaned with household soap only. Solvents deteriorate plastics and will cause cracking.**

### Clamping Pressure Regulator

- Clamping Pressure Regulator (26) controls the clamping pressure of the of the rollers on the part (See Figure 6). The greater the pressure, the tighter the tape will be wrapped on the part.
- Clockwise rotation of the regulator knob increases



the amount of clamping pressure; counter-clockwise rotation decreases clamping pressure. This regulator is factory set and only minor adjustments for preference would be needed.

**NOTE: High clamping pressure will cause the rollers to wear faster.**

### Part Changeover

**To wrap a part of a different diameter, thread length and/or threads per inch, the following parameters may need to be adjusted:**

- **Tape cartridge** – tape width should be appropriate for part thread length. (See Section 2, Tape Cartridge Mounting and Adjustment)
- **Tape position within Anvil** – adjust for part thread length and tape width. (See Section 2, Tape

### Cartridge Mounting and Adjustment)

- **Trigger Rod** – substitute according to part diameter. (See Section 2, Trigger Rod Selection and Installation)
- **Threaded Teflon Roller** – roller threads must match the threads per inch of part to be wrapped. (See Section 2, Roller Selection and Installation)
- **Part location** – adjust for part thread length. (See Section 2, Part Location)
- **Centering Disc position** – adjust for part diameter. (See Section 3)
- **Number of wraps** – adjust according to preference. (See Section 3)
- **Clamping pressure** – adjust according to preference. (See section 4, Clamping Pressure Regulator)

## SECTION 5: TROUBLESHOOTING PROCEDURES

**The Thred Taper can be cycled manually in order to watch the sequence of functions. This procedure is usually very helpful for identifying irregularities of operation. Two people are required to perform this technique.**

1. Turn the On/Off Switch (7) to the “on” position.
2. Open hinged cover.
3. Another person should hold a part securely while pushing it against the Trigger Rod (27) to the mechanical stop and hold.
4. Press the Motor Brake Release (60) down. (See Figure 11)
5. Slowly rotate the Face Plate Assembly (10) counter-clockwise and watch for the following sequence to occur (See Figure 6):
  - Tape cartridge drops down, with the “O” ring just touching the Anvil (36). The tape should

now be straight and tangential to the Sliced Rubber Roller (38).

- The three clamping arms (24, 25 and 30) close and the rollers surround the part, placing the tape on the part as the Face Plate turns.
- The tape cartridge returns to the up position.
- The tape is cut (you should hear a clicking sound).
- The Face Plate Assembly (10) returns to the initial position and the clamping arms open.

**NOTE: Since this procedure is meant only for troubleshooting, less than a single revolution of tape will be applied.**

6. If any of the actions do not occur, refer to the Problems/Solutions tables in Section 6.

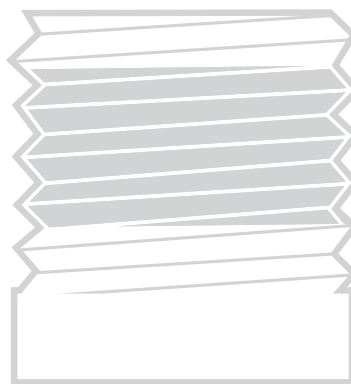
## SECTION 6: PROBLEMS/SOLUTIONS

Problem	Possible Cause	Solution
Machine not cycling.	Electricity not connected.	Plug machine into electrical outlet.
	The power switch in the “off” position.	Turn On/Off Switch (7) to “on” position.
	Loose or broke electrical wires.	Replace broken wires or tighten loose ones.
	Lid not closed.	Close lid to engage automatic shut-off safety switch.
	Wrap number selector switch (1) is set between wraps.	Turn wrap number selector switch to desired number.
Tape not sticking to part.	Oil on part or rollers.	Clean fittings and rollers with soap and water.
	Rollers on backwards.	Remove rollers and turn them around so that the taper goes from back to front.
	Worn brass roller hubs.	Replace brass hubs.
	Clamping pressure too loose.	Increase clamping pressure using the Clamping Pressure Regulator (26) on Face Plate.
	Incorrect Teflon Roller.	Replace Teflon Roller (28) with correct roller.
	Part not held perpendicular.	Hold part perpendicular to machine.
	Tape hitting anvil and curling the tape carrier goes down.	Bend metal cartridge guides either forward or backward to correct problem.
	Feed air pressure below 90 psi.	Adjust feed air pressure to 90 psi.
	Tape not coming down far enough to reach fitting.	Adjust Stop Block (39) using Allen wrench.
Rollers riding on wrench flats or trigger rod.	Adjust part position using the Part Positioning Knob (3) or change to smaller Trigger Rod (27).	

<b>Problem</b>	<b>Possible Cause</b>	<b>Solution</b>
Tape not sticking to part.	Unclean rubber rollers sleeves.	Replace roller sleeves.
	Tape not catching on smooth plastic part.	Exchange Teflon Roller (28) with Sliced Rubber Roller (38).
Machine not cutting tape.	Dull Blade and/or Anvil.	Sharpen Blade (37) and Anvil (36) or return for factory service.
	Dirt between Blade and Anvil.	Loosen the two screws that hold Blade (37) and Anvil (36), making sure not to lose the spring or ball bearing. Clean parts with solvent. Dry and replace all parts making sure the blade is riding in groove.
	Feed air pressure below 90 psi.	Adjust feed air pressure to 90 psi.
Tape tears while wrapping a part not allowing machine to wrap again.	Tape stuck in cartridge.	Remove cartridge from machine and flex it. Rethread tape into Anvil (36) and place cartridge back on machine.
	Metal tabs on cartridge getting pinched between the part and roller.	Adjust Stop Block (39) up.
Rollers wearing to quickly.	Clamping pressure too tight.	Decrease clamping pressure using the Clamping Pressure Regulator (26) on Face Plate.
	Rollers riding on the part shoulder/ wrench flats.	Adjusting part position out using the Part Positioning Knob (3).
Tape bunches up on part or generally a poor wrap.	Worn brass roller hubs (if rollers not rotating).	Apply grease to axles. Replace brass hubs.



# THRED TAPER



THE WORLD'S ONLY AUTOMATIC TAPE WRAPPER

[www.ThredTaper.com](http://www.ThredTaper.com)



**FEDERAL PROCESS**  
CORPORATION

4520 Richmond Road | Cleveland, OH 44128  
(216) 464-6440 | (800) 846-7325